

Smart Communication Server

SL1000

Multi-Line Terminal

User Guide

**Please read this manual carefully before operating
this product and save this manual for future use.**

Before using Your Terminal...

Thank you for purchasing NEC SL1000 system.

Due to the flexibility built into the system, your **Dialing Codes and Feature Capacities** may differ from those in this guide. Check with your NEC Authorized Supplier / System Administrator and make a note of any differences.

Installing the Handset and Line Cord

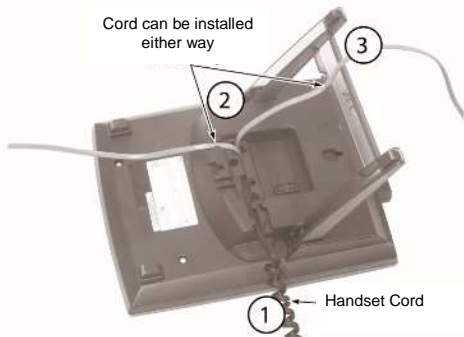

When installing the handset :

1. Make sure the handset cord is plugged into the handset jack on the telephone base.
2. The line cord routes through the channel on the telephone base.
3. Alternatively the line cord can route through the channel on the telephone legs.

Adjust the two-position Viewing Angle

To set the low viewing angle position:

1. Fold the legs all the way back.

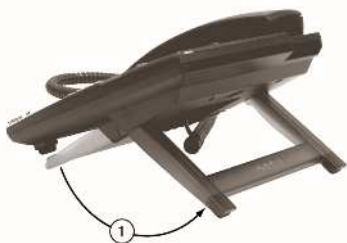

To set the high viewing angle position:

1. Flip up the two leg supports.
2. Fold the legs back until the supports contact the base.



NEC Corporation reserves the right to change the specifications, functions, or features at any time without notice. NEC Corporation has prepared this document for use by its employees and customers. The information contained herein is the property of NEC Corporation and shall not be reproduced without prior written approval of NEC Corporation.

Copyright 2011, NEC Corporation

Printed in Japan

Using Your Terminal

■ IP4WW-()*TXH-A TEL

Handset

Call Indicator Lamp
This lamp flashes fast when a call is ringing and flashes slower when a message has been left.

Alphanumeric Display
The LCD has 2 lines with 16 characters.

Exit Key
Exit any screen and return the display to "Time & Date".

Help Key
The user can press this key followed by a programmable key to check what Line or Programmable Feature is assigned on the key.

Programmable Function Keys
Flexible Line keys or Feature Keys assigned by the System Administrator.

Flash Key
Press key to finish an outside call and hear the dial tone.

Transfer Key
Allows the extension user to transfer established calls to another extension.

DND/CONF Key
(Do Not Disturb / Conference)
Setup a Do Not Disturb or Conference if pressed during a call.

Mute (Microphone) Key
Mute handset or Handsfree Microphone. LED lights when microphone is muted.

Clear/Back Key
Press this key to cancel the current action or delete a character.

Cursor Key
Access various features with simple operation.

Dial Keys

Speaker

Speaker Key
Controls the built-in speaker which can be used for Handsfree dialing/monitoring. LED on key lights when key is active.

HOLD Key
Press this key to place an internal or external call on hold.

Volume (UP) Key

Redial Key

Enter Key

Directory Functions or Volume (DOWN) Key

Speaker

Flash

Transfer

Mute

DND/CONF

Clear/Back

Speaker

Hold

* 12 Programmable Function Keys are available for IP4WW-12TXH-A TEL.
24 Programmable Function Keys are available for IP4WW-24TXH-A TEL.
** The illustration shows IP4WW-24TXH-A TEL.

Handsfree Options

- Handsfree lets you place and answer calls by pressing "Speaker" instead of using the handset.
- With Automatic Handsfree, you can press a Speaker Key without lifting the handset. Normally, you have Automatic Handsfree.
- Use Handsfree Answerback to answer a voice-announced Intercom call by speaking toward your phone without lifting the handset.

For Your Convenience

■ Programmable Function Keys

Programmable Function Keys can be assigned as “Trunk” Key and/or other Function Keys. You can just press the function key to activate the assigned function without dialing the Service Code.

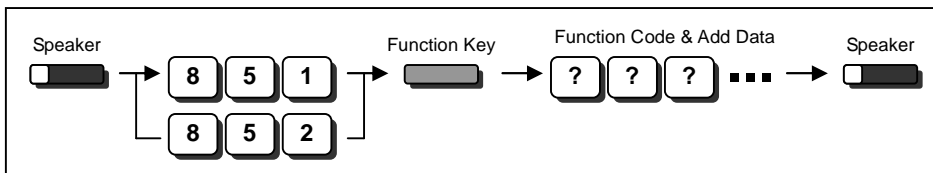

- There are 2 levels of Function Keys. (General Keys : assigned by **851**, Appearance Keys : assigned by **852**)
- Appearance Keys have priority. You can overwrite the Appearance Key at the General Key.
- If you want to overwrite the General Key at the Appearance Key, you have to erase the Appearance Key by dialing “**852 + 000**” before General Key assignment.
- In the default setting, Programmable Function Key No. 1 to 12 is assigned as “Trunk” Key. If you want to assign Function Keys (General) at the unused Trunk Keys, these unused keys should be erased by “**852 + 000**” operation.
- Programmable Function Keys can be erased by dialing “**852 + 000**” or “**851 + 00**”.

■ DSS / One-Touch Keys

Programmable Function Keys can be assigned as DSS (Direct Station Selection) or One-Touch Keys. You can place an Outside / Intercom Call by just pressing this key without dialing the number.

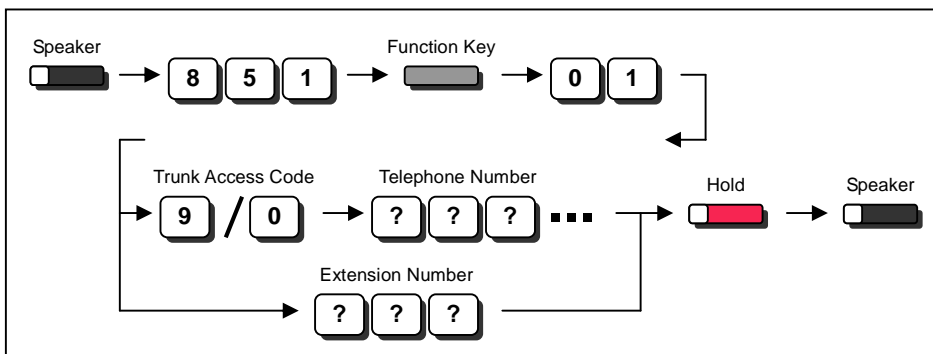

- To change the Trunk Access Code, Ask your NEC Authorized Supplier for the details.
- In the default setting, Programmable Function Key No. 1 to 12 is assigned as “Trunk” Key. If you want to assign DSS Keys at the unused Trunk Keys, these unused keys should be erased by “**852 + 000**” operation before the above operation.
- In case of DSS Key, the extension status can be indicated on the BLF. (idle : extinguished, Busy : lit)
- When you register a telephone number, the Trunk Access Code should be added in front of the number.
- Up to 36 digits dialing can be registered, but the name can not be registered.
- If you want to continue the operation, press Programmable Function Key instead of Speaker Key to finish.

For Your Convenience

■ Abbreviated Dial (Speed Dial) Registration

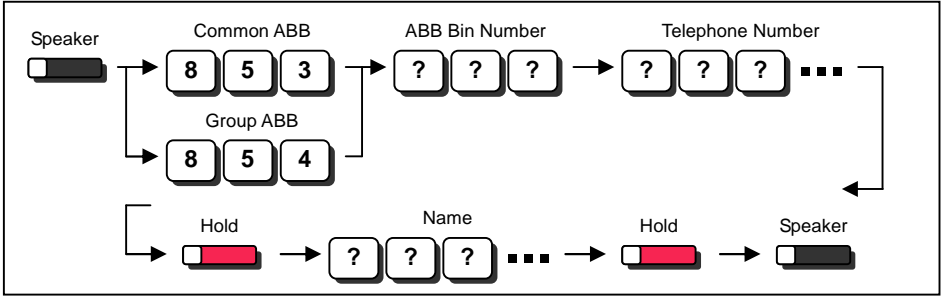

- The digit of Bin No. depends on the system setting. (0-9<Only Group ABB> / 00-99 / 000-999)
- System setting is necessary for Group ABB function. Ask your NEC Authorized Supplier for the details.
- Name can be entered by Dial Pad Keys. (See below)
- Up to 36 digits dialing can be registered, and up to 12 characters can be registered as name.
- If you want to continue the operation, dial Bin No. instead of Speaker Key to finish.
- You can skip to enter the name. (No enter any character, then press "Hold" Key).
- You can erase the registered number & name by pressing "Exit" Key after dialing Bin No..

■ Entering Alphanumeric Characters

When you enter a name, use Dial Pad Keys to enter letters as below. For example, press "2" key once for "A", twice for "B", etc...

Accepts a character and move the cursor one place to the right. Press twice to insert a "space".

Clear/Backspace Clear the character entry to the left, one character at a time. (Backspace)

1: 1 @ [¥] ^ _ ' { | } → ← Á Â Ã Ä Å Æ φ Ó Ì Ê Ë Ç

2: A B C a b c 2

3: D E F d e f 3

4: G H I g h i 4

5: J K L j k l 5

6: M N O m n o 6

7: P Q R S p q r s 7

8: T U V t u v 8

9: W X Y Z w x y z 9

0: 0 ! " # \$ % & ' () Ò Ò ú á ä æ ö ü α β θ ε

*: * + , - . / : ; < = > ? π Σ σ Ω ∞ € £

Placing Calls

■ Place an Outside Call <Quick Access>

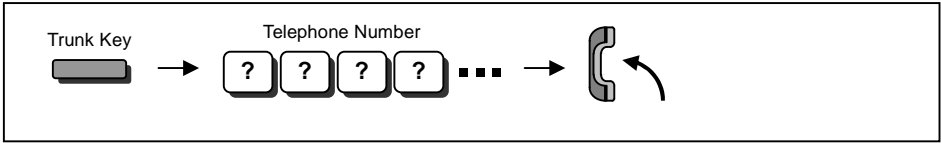

- Listen to the Dial Tone before dialing a Telephone Number.
- You can have function keys for Trunks or Trunk Groups. Ask your NEC Authorized Supplier for the details.

■ Place an Outside Call <Access by Code>

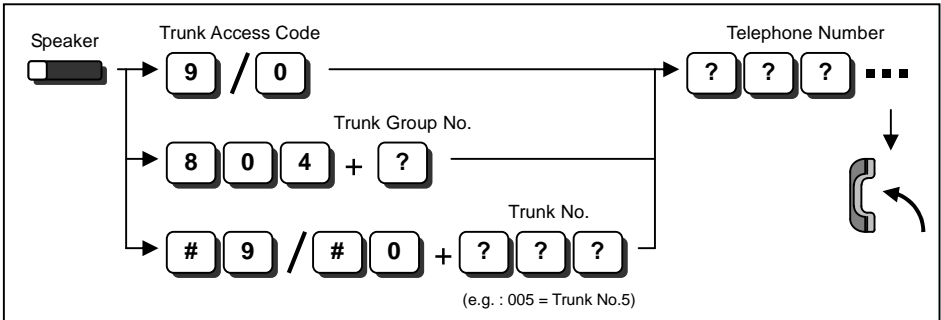

- To change the Trunk Access Code, Ask your NEC Authorized Supplier for the details.
- Listen to the Dial Tone before dialing a Telephone Number.
- In case the number of Trunk Group is more than 10, you should enter 2 digits (e.g. 11 : Group 11) after dialing "804". Ask your NEC Authorized Supplier for the details.
- For the dial digit of Trunk No., ask your NEC Authorized Supplier for the details.

■ Place an Intercom Call <Dial Access>

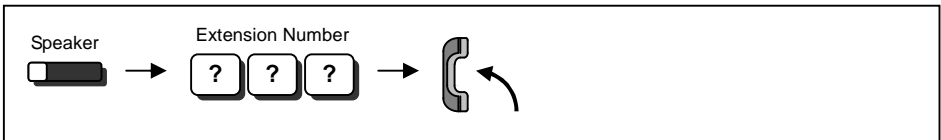

- Your call will ring or voice-announce. If you hear ringing, wait for an answer. If you hear a beep, begin speaking. Dialing "1" changes voice/ring mode. (in case the destination is Multi-line Terminal)

Placing Calls Quickly

■ Directory Dialing

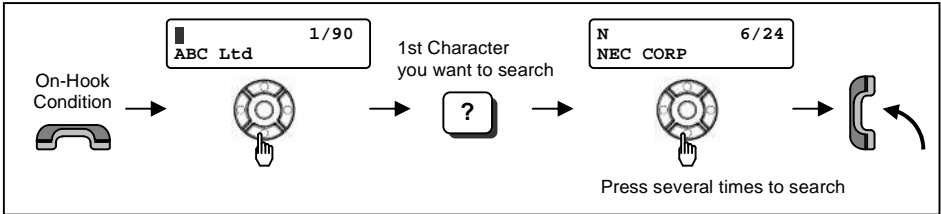

- After searching the desired destination, press "Enter" Key to confirm the telephone number before lifting the handset, if necessary.
- You can enter more Characters (up to 12) to make desired destination's search even more specific.
- You can also search the desired destination without entering the Characters. (press Cursor Keys only)
- To cancel the Directory Dialing operation, press "Clear/Back" Key.

■ Last Number Dialing

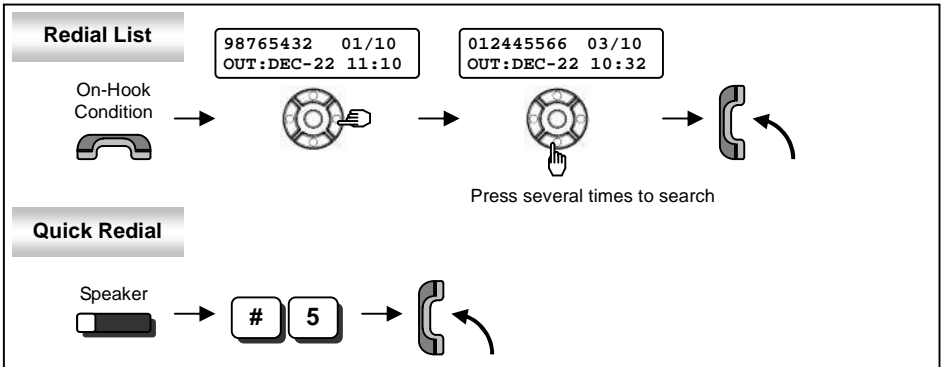

- The system retains the last 10 numbers dialed which can be reviewed and redialed.
- To cancel the Redial List operation, press "Clear/Back" Key.

■ Callback by Received Number

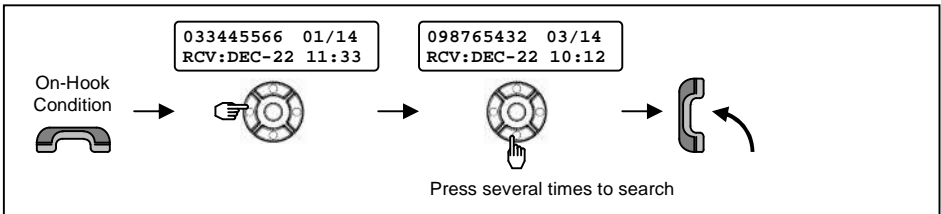

- Caller-ID function is required to use this operation for outside calls. Ask your NEC Authorized Supplier for more details.
- To cancel the Callback operation, press "Clear/Back" Key.

Placing Calls Quickly

■ Abbreviated (Speed) Dialing <for Outside>

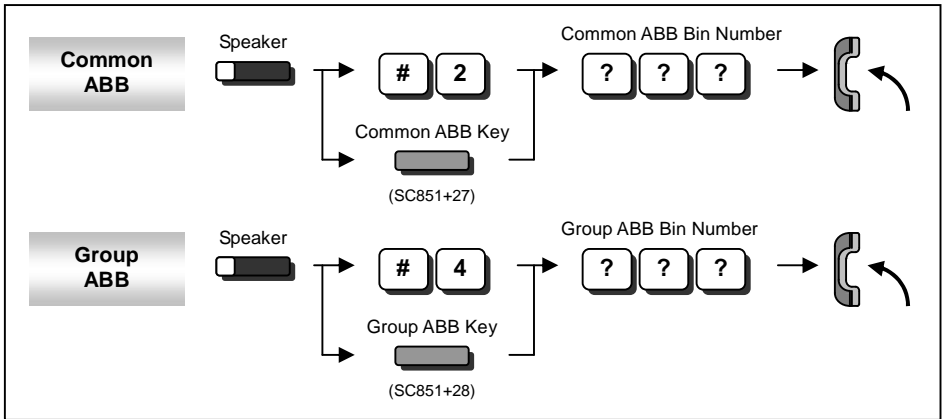

- The digit of Bin No. depends on the system setting. (0-9 <Only Group ABB> / 00-99 / 000-999)
- Telephone Numbers shall be pre-registered to the system.
- System setting is necessary for Group ABB function. Ask your NEC Authorized Supplier for the details.
- When you assign the Common ABB Key on the Programmable Function Key, "Press HOLD" is required after dialing the Function Code 27.

■ One-Touch / DSS Call

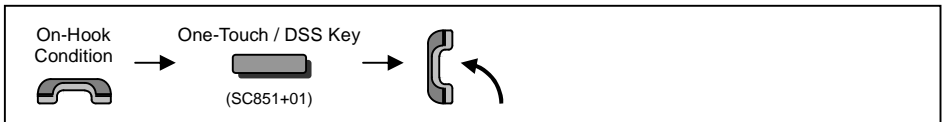

- Telephone / Extension number should be pre-registered to a One-Touch / DSS Key.
- Trunk Access Code should be added in front of the Telephone number.

If your call doesn't go through...

■ Set Camp On / Callback

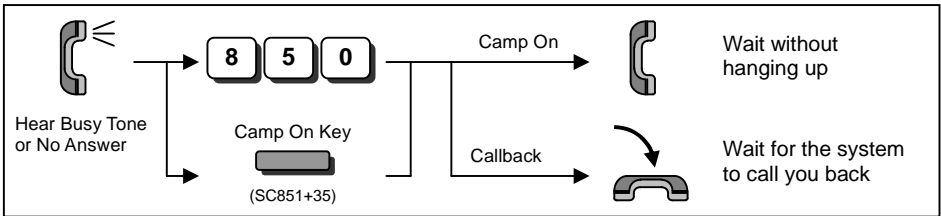

- **Camp On** In case of Intercom Call, when you hear ringing, wait for the called party to answer.
In case of Outside Call, when you hear Dial Tone, begin telephone number dialing.
- **Callback** In case of Intercom Call, when your terminal starts the ringing, lift handset and wait for the called party to answer.
In case of Outside Call, when your terminal starts the ringing, lift handset, hear Dial Tone, and begin telephone number dialing.
- This function is applicable in case all trunks are busy condition. (not applicable for dialed outside party busy)

■ Cancel Camp On / Callback

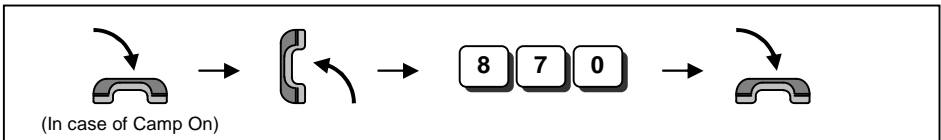

■ Repeat Dialing <Outside Call Only>

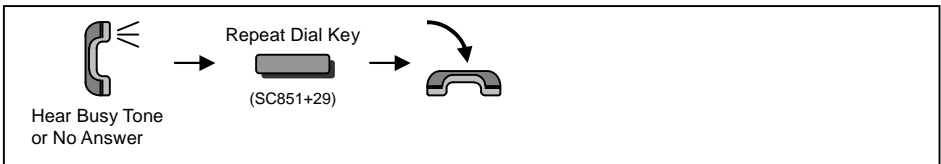

- When the Repeat Dialing is set, Repeat Dial Key shall flash and the system automatically and periodically redials a call. Repeat duration is programmable. Ask your NEC Authorized Supplier for the details.
- You should lift the handset when the called party answered.
- Press flashing Repeat Dial Key to cancel.

If your call doesn't go through...

■ Set a Message Waiting

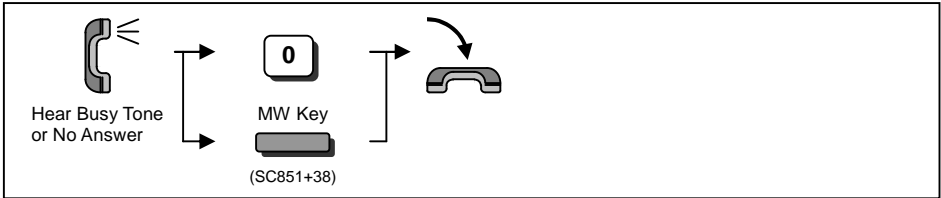

- When you set a MW, the called party's Indicator starts to flash, and your Indicator is lit in Red.

■ Answer a Message Waiting (Your terminal's Indicator is flashing in Red)

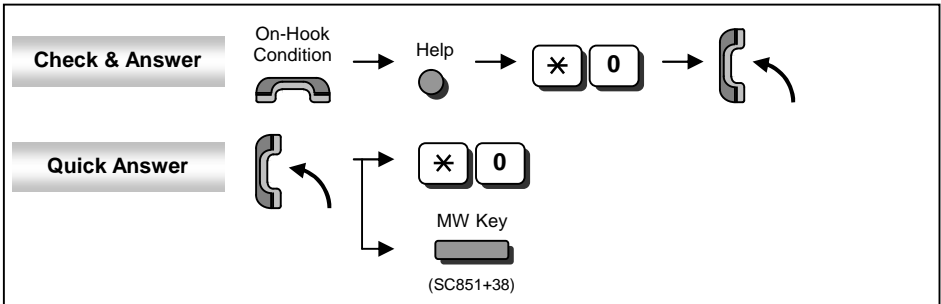

- When you answer a MW, the Indicator shall automatically be off when the called party answers.
- You can select the desired party by pressing Up Key after dialing " * , 0", if several number of Message Waiting has been set.

■ Cancel Message Waiting

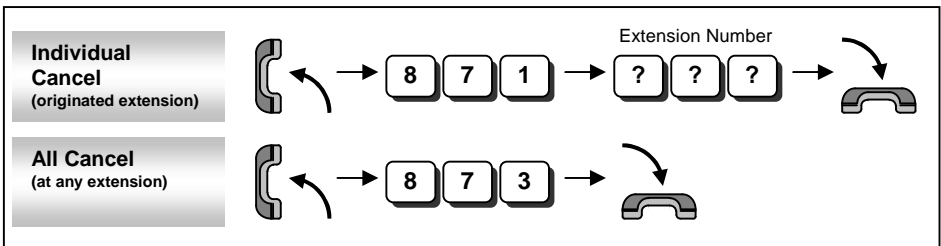

Answering Calls

■ Answering an Outside Call

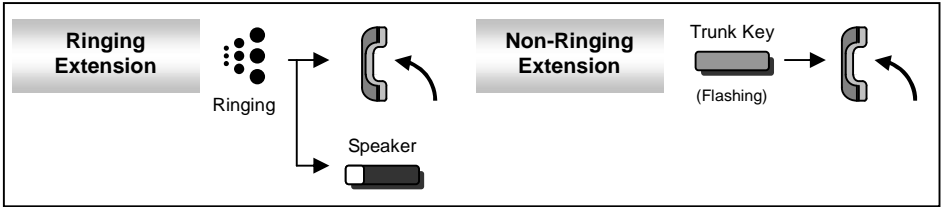

- Confirm the status of Mute Key if you want to answer by Handsfree. (Mute On : LED On, Mute Off : LED Off)

■ Answering an Intercom Call

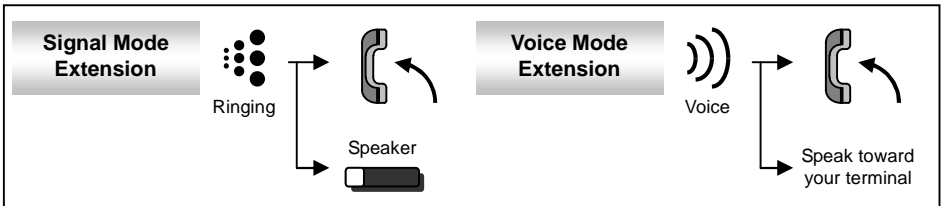

- Intercom Call Mode (Signal or Voice) can be set at your terminal by :
 "Signal" : Speaker -> 823 "Voice" : Speaker -> 821
- Confirm the status of Mute Key if you want to answer by Handsfree. (Mute On : LED On, Mute Off : LED Off)

■ Picking up a Call for other Extensions

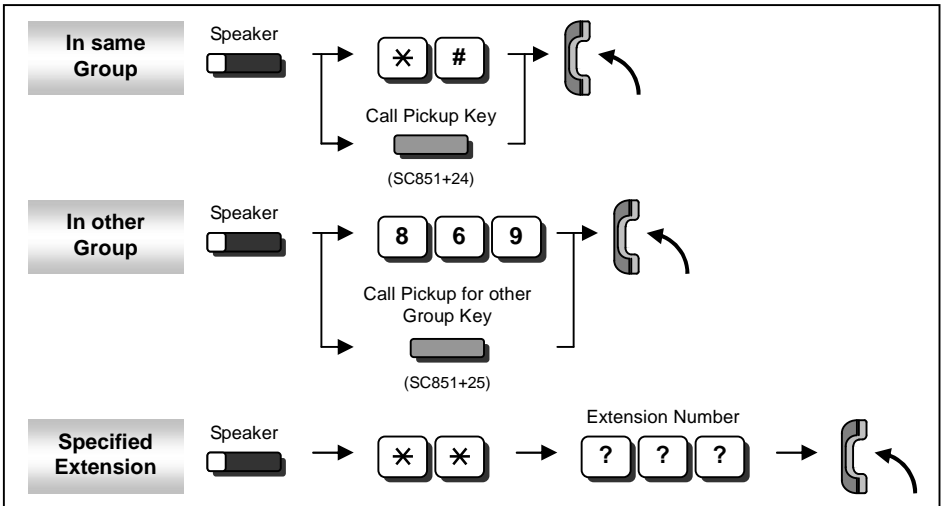

- System setting is necessary to make Call Pickup Group. Ask your NEC Authorized Supplier for the details.

Hold / Transferring Calls

■ Holding a Call / Retrieving a Held Call

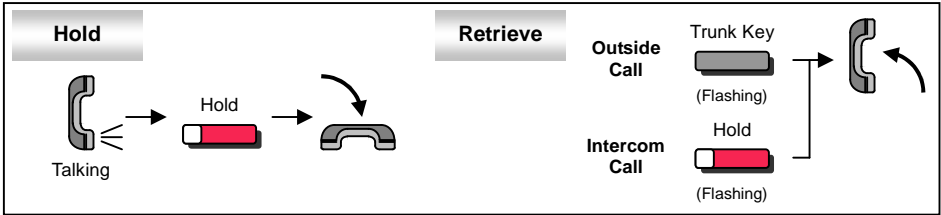

- In case of Intercom, the call shall be held as “Exclusive Hold” on your terminal.
- This operation puts your outside call on System Hold. Other extension user can take the call off Hold.

■ Holding a Call Exclusively

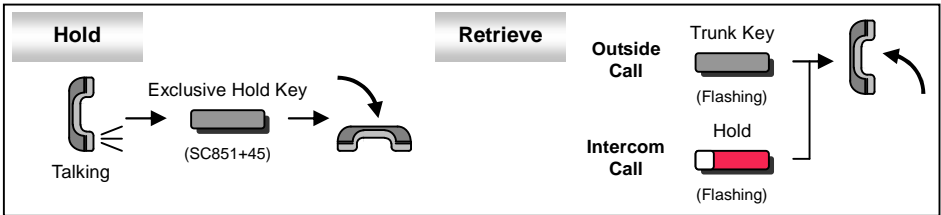

- This operation puts your outside call on Exclusive Hold. Other extension user can not take the call off Hold.

■ Retrieve a Held Outside Call

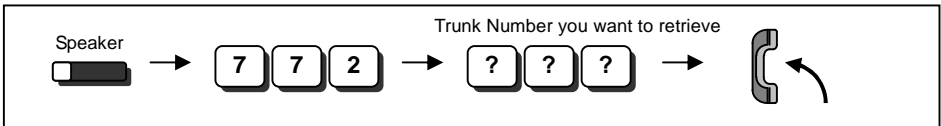

- For the dial digit of Trunk Number, ask your NEC Authorized Supplier for the details.

■ Transferring a Call to the other Extension

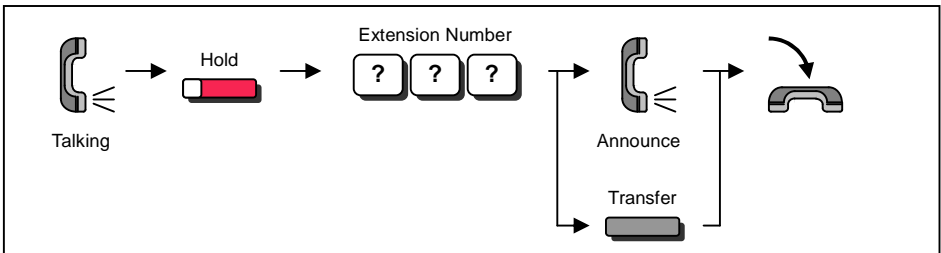

- If your terminal has DSS/One-Touch key, just press it instead of “HOLD” and “Extension Number” dialing.

For more Convenient Use...

■ Do Not Disturb (DND)

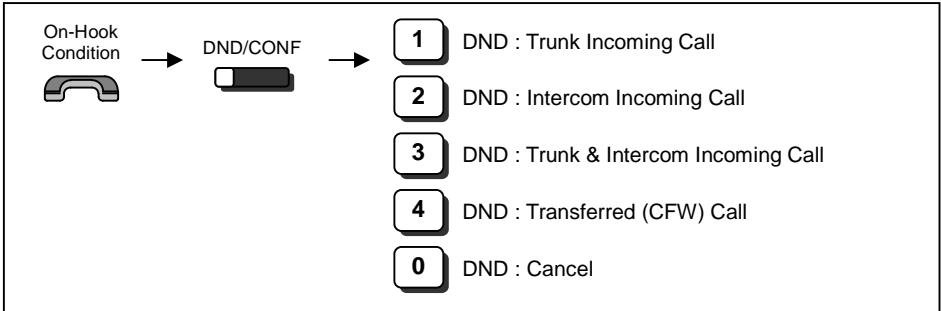

- When you set DND function, DND/CONF Key shall be lit and the Internal Dial Tone pattern shall be changed.

■ Conference

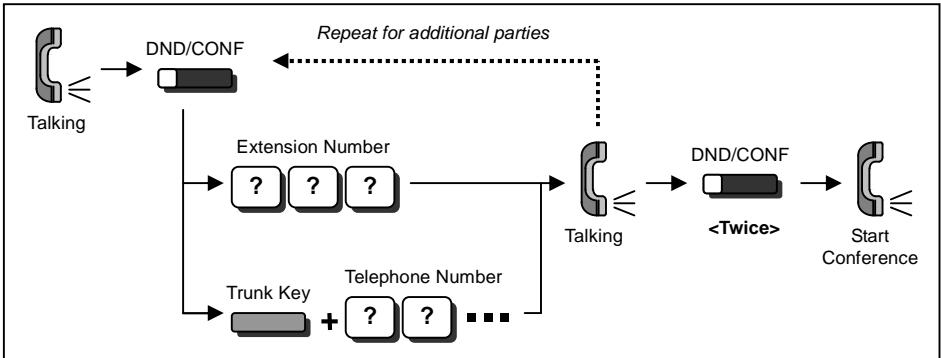

- You can repeat this operation to add more parties.
- You may be able to have up to 16 parties. (include your terminal) May need to adjust the volume level due to the Environment where calls are placed. Ask your NEC Authorized Supplier for the details.

■ Call Forwarding / Follow Me

When you set Call Forward / Follow Me function, the destination extension shall be displayed on the LCD, and the Internal Dial Tone pattern shall be changed.

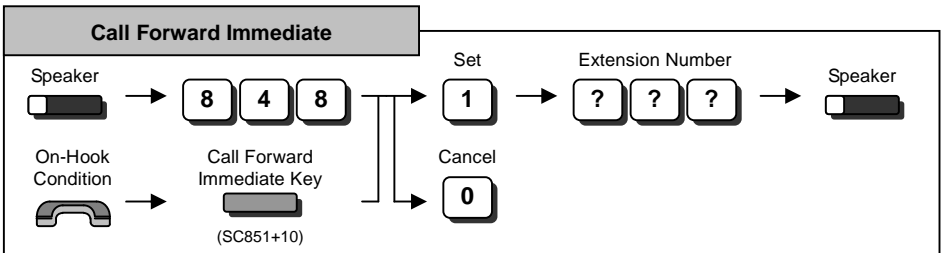

For more Convenient Use...

■ Call Forwarding / Follow Me (Cont'd)

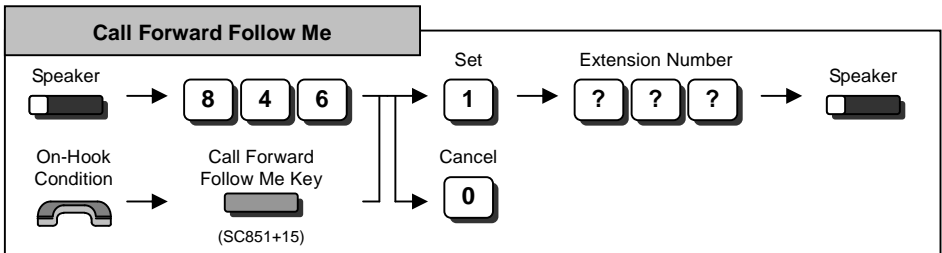
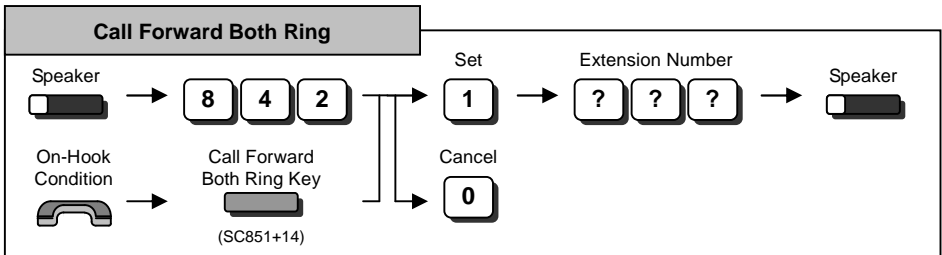
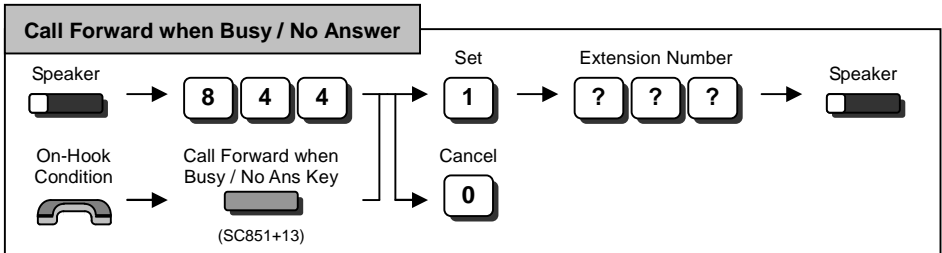
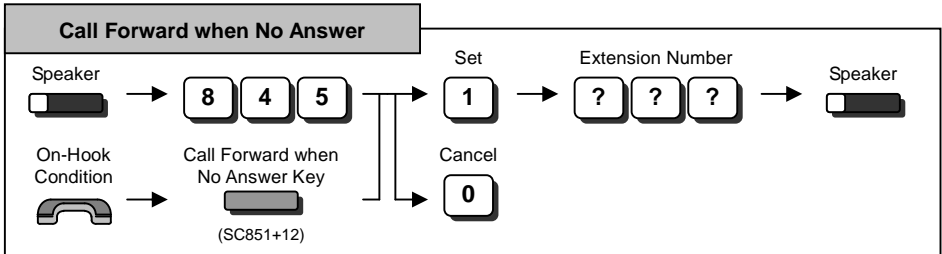
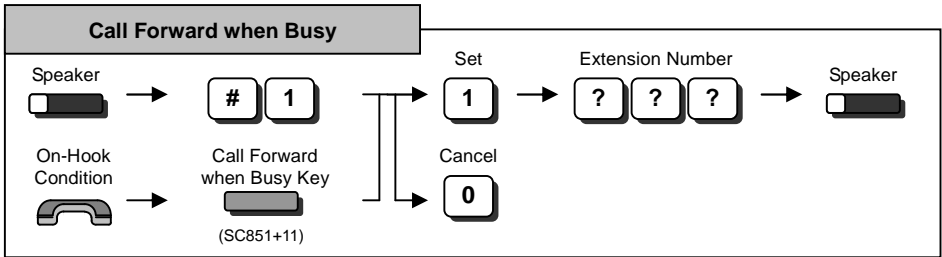

Cursor Keys Operation

■ Menu Structure

The following table shows the menu structure of the Cursor Keys. You can reach the desired menu by pressing Cursor Keys (Up / Down / Right / Left) or dial 3 digits for shortcut access after pressing the "Enter Key" to activate a menu.

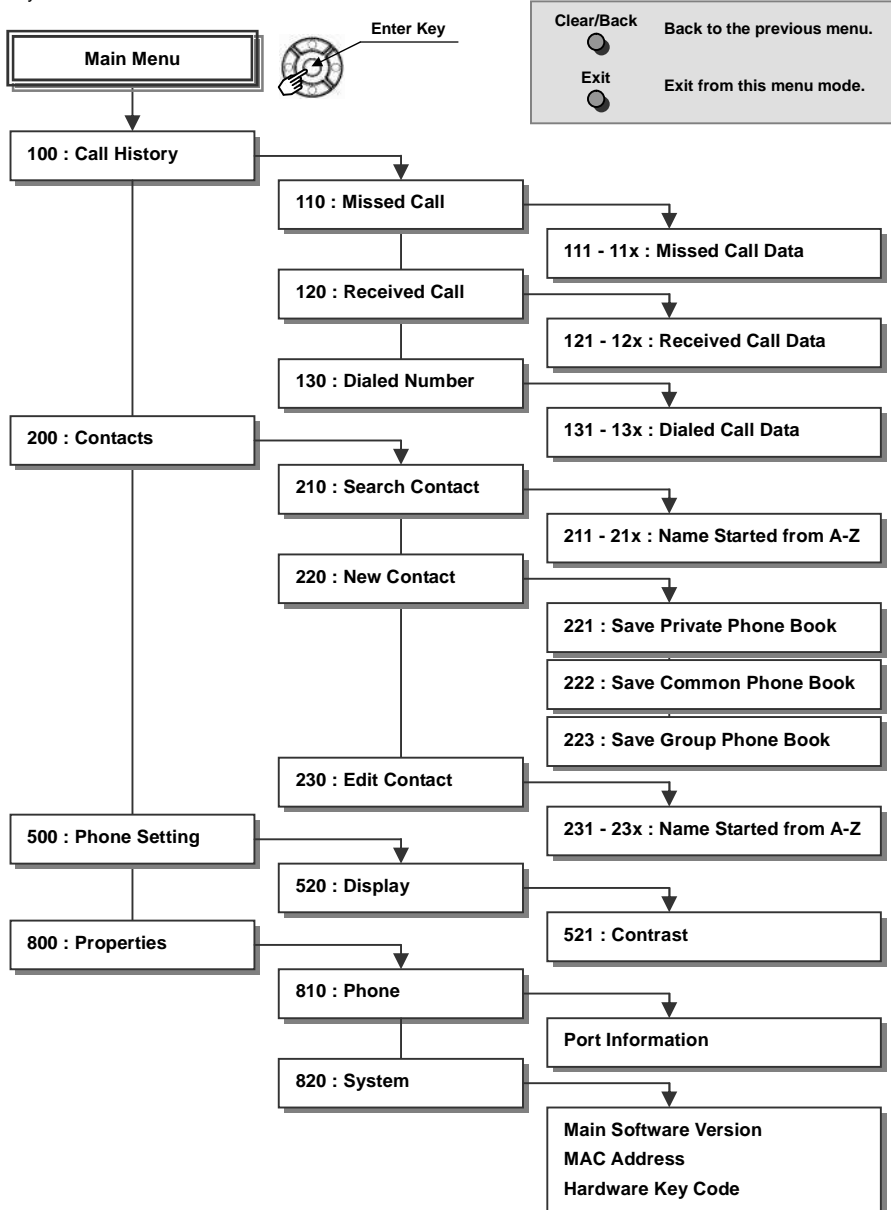

Built-In Answering Machine (VRS Message)

System setting is necessary to use Built-In Answering Machine. Ask your NEC Authorized Supplier for the details.

Record / Listen / Erase Answering Messages

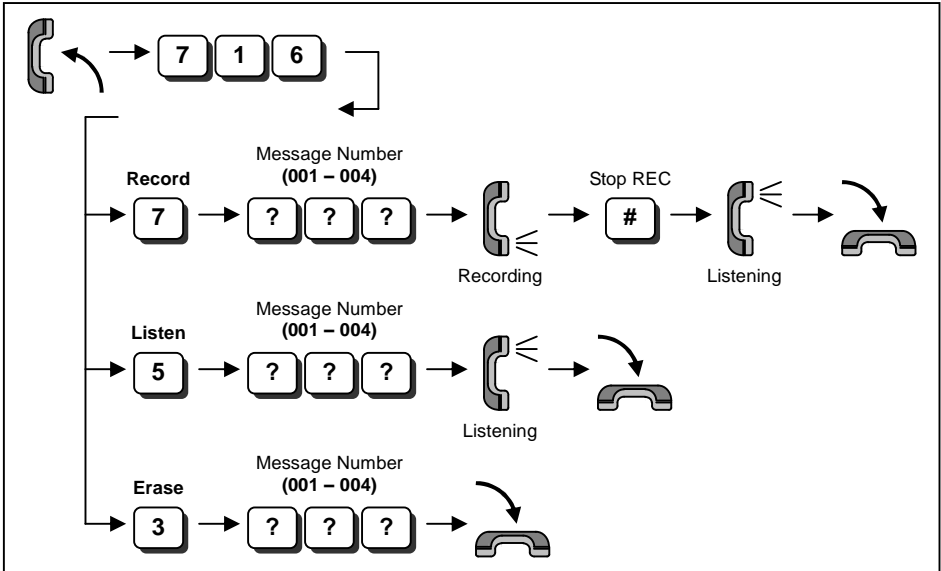

- Up to 4 types of messages can be recorded.
- The Message length can not exceed 2 minutes.

Built-In Answering Machine (Voice Mail Message)

Listen / Erase Left Messages

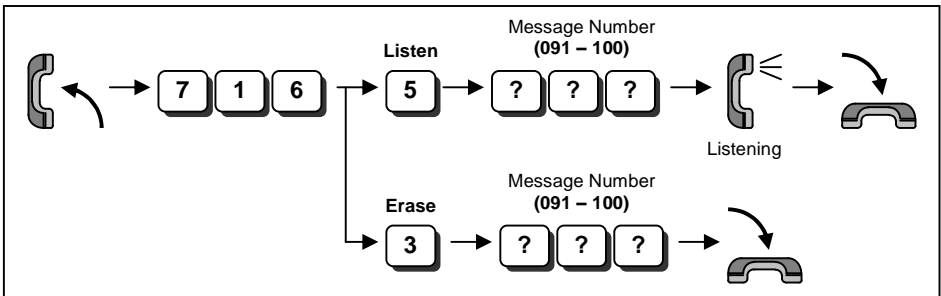

- Up to 10 messages can be left from outside.
- The Message length can not exceed 2 minutes.

Option : In-Mail (Voice Mail)

Optional hardware and System setting is necessary to use In-Mail (Voice Mail) feature. Ask your NEC Authorized Supplier for the details.

■ Log-On to the In-Mail

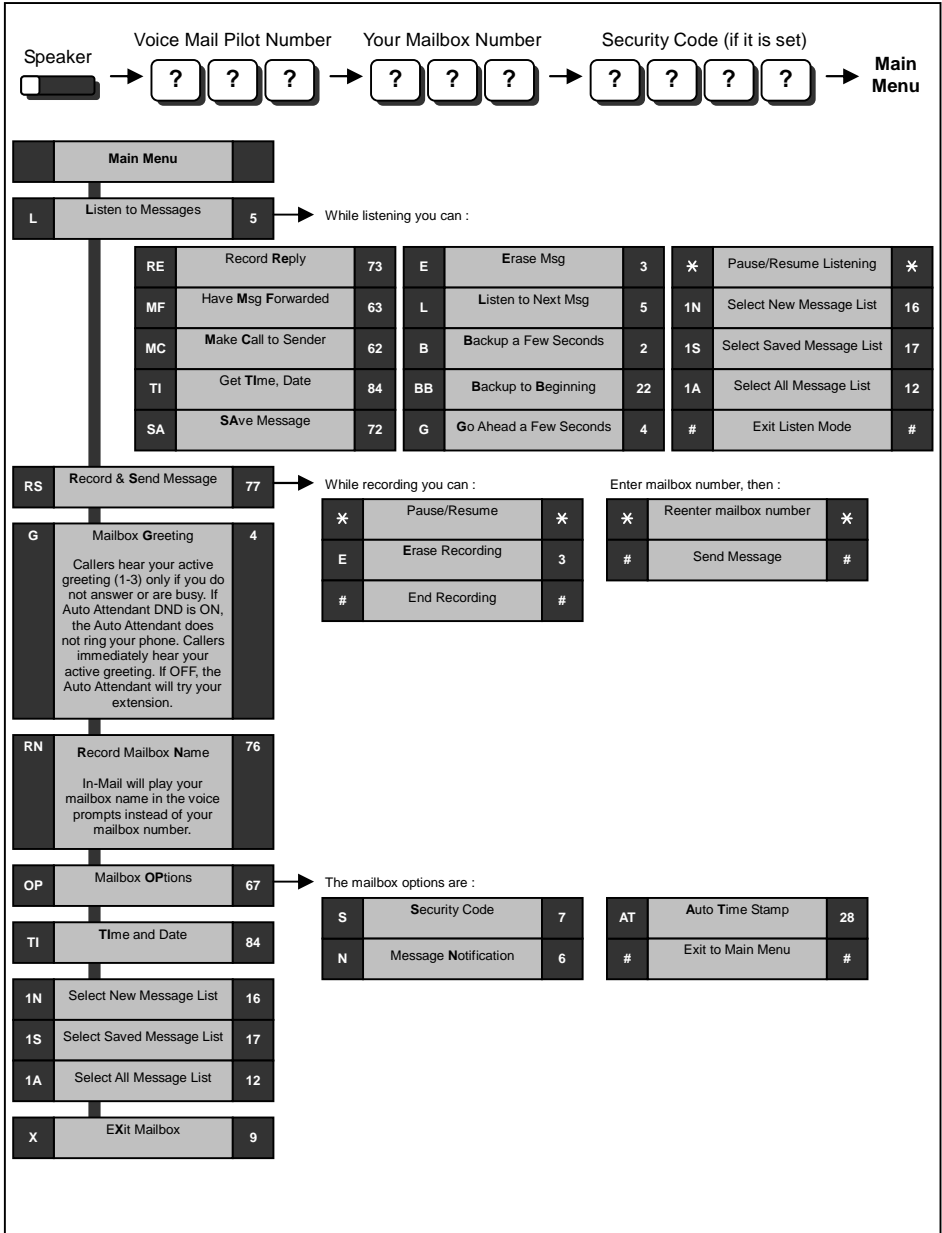

Option : In-Mail (Voice Mail)

■ Call Forward to Voice Mail

Convenient Operation by Function Key



Auto-Attendant Key



(SC851+79 + Ext No.)

Press "Automated Attendant" Key several times to change the status. (All Calls -> No Answer -> Busy -> Busy/No Answer -> Cancel)

Forward All Incoming Calls

Speaker



Set



Voice Mail Pilot Number

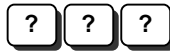

Speaker



Call Forward Immediate Key



(SC851+10)

Cancel



Forward Incoming Call when Busy

Speaker



Set



Voice Mail Pilot Number

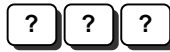

Speaker



Call Forward when Busy Key



(SC851+11)

Cancel



Forward Incoming Call when No Answer

Speaker



Set



Voice Mail Pilot Number

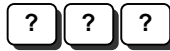

Speaker



Call Forward when No Answer Key



(SC851+12)

Cancel



Forward Incoming Call when Busy / No Answer

Speaker



Set



Voice Mail Pilot Number

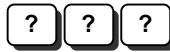

Speaker



Call Forward when Busy / No Ans Key



(SC851+13)

Cancel



Option : In-Mail (Voice Mail)

■ Mailbox Greeting

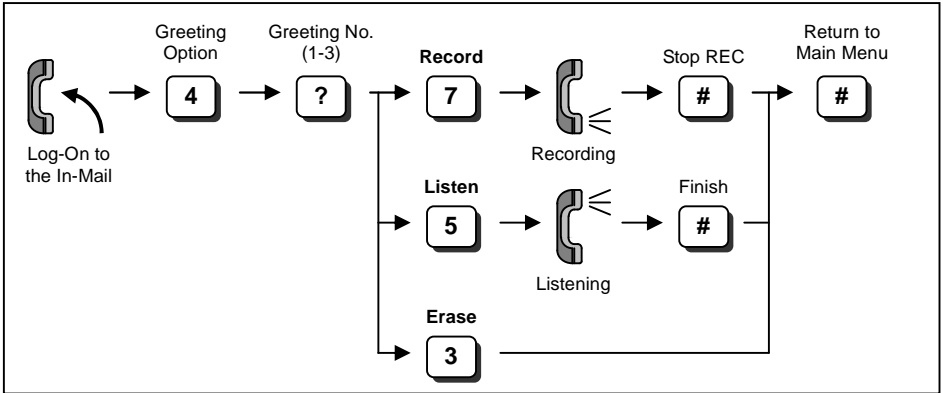

- Selected Greeting (one of three) shall be made active.

■ Mailbox Security Code

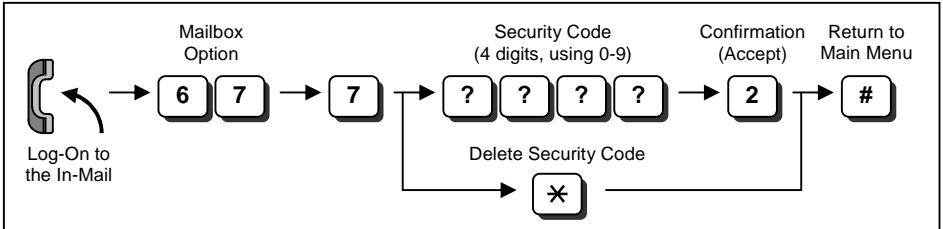

- Dialed Security Code can be canceled by pressing "4" instead of "2 (Accept)".
- System Administrator can delete a Mailbox Security Code.

■ Listen to Left Messages in your Mailbox

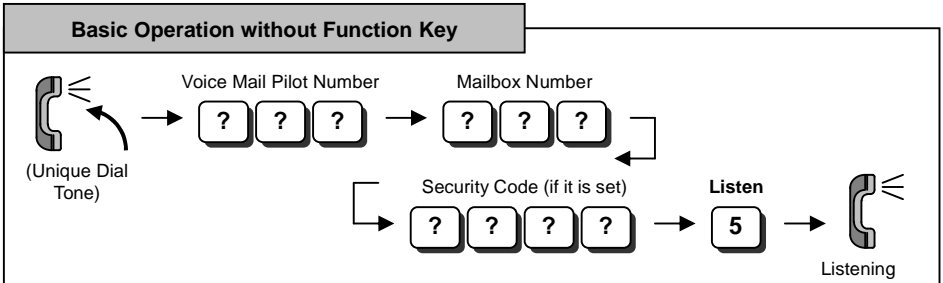
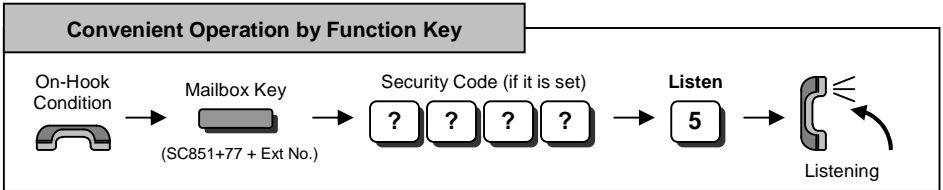

A50-031674-101
Issue 1.1
February 2011

SL1000

Multi-Line Terminal
User Guide

NEC Corporation